

From Energy Audits to Monitoring Megawatt Loads: A Flexible and Deployable Power Metering System

Bradford Campbell
University of Virginia
bradjc@virginia.edu

Ye-sheng Kuo
University of Michigan
samkuo@umich.edu

Prabal Dutta
University of California, Berkeley
prabal@berkeley.edu

Abstract—

The U.S. Federal Government and commercial partners have identified a critical gap in today’s measurement technology—the ability to accurately, inexpensively, and wirelessly submeter building electricity usage at the circuit-level. Such metering technology would enable building owners, operators, and occupants to characterize and curtail electricity use in buildings—a major cost and source of carbon emissions today. Existing circuit-level metering systems are too costly to deploy, due to difficult installation or cumbersome calibration processes, too inaccurate, due to an inability to faithfully calculate power from synchronized current and voltage channels, or too unreliable, due to a strong dependence on a frequently lossy wireless channel. We propose *Triumvi*, a standalone, self-powered, non-contact, true-power metering system to help make circuit-level metering affordable, accurate, and reliable—in short, usable. In a split-core current transformer form factor, *Triumvi* harvests energy to power itself, monitors current and voltage, calculates power, encrypts data, and wirelessly transmits the results. Our prototype can sustain a sample rate of nearly 0.5 Hz when the load draws at least 360 W and exhibits an average error of 4.3% over a load power draw range of 150-600 W. *Triumvi* also supports rapid installation, incremental upgrades, metering three phase and high current loads, charge sharing between meters, and current waveform analysis, creating a highly flexible metering system capable of energy audits, industrial equipment monitoring, and many applications in-between.

I. INTRODUCTION

We present *Triumvi*, an energy-harvesting energy metering system for profiling electrical circuits at various points in the load tree. This system addresses a range of use cases, from quick residential energy audits that do not require revenue-grade accuracy to sophisticated three-phase industrial loads that require power factor monitoring but cannot afford system shutdown for installation, and many points in between. Sensor data can be viewed locally or sent to the cloud for analytics, reporting, and visualization. Collectively, this system addresses many of the challenges identified with building energy monitoring [1, 23, 28], and builds on prior work from both commercial [2, 8–11, 13] and research [15, 16, 18, 22, 24, 25, 29] settings, to address the U.S. Department of Energy’s calls for new methods of power metering [19, 20].

Today, no metering system adequately addresses key deployability concerns. Unfortunately power meters that are expensive, wired, hard to install, inaccurate, inflexible, or difficult to calibrate or configure impose a high barrier to submeter deployment. To make power metering more useful, researchers have focused on two areas: (i) smaller and less invasive metering

devices that are easy to install and (ii) non-intrusive load monitoring (NILM) techniques [14] that use a single watchpoint and disaggregate loads based on changes to properties of the aggregate. To avoid the drawbacks of NILM, namely runtime calibration, load profiling, and electrical topology dependence, we focus on individual power meters that can measure AC circuits in a panel box or large, often three-phase, loads that are hard-wired to a panel.

Our power metering system uses a modular design comprising an easy-to-deploy non-contact power meter, a configuration module, a wireless radio, a wireless gateway, and a visualization and download tool. At the core of the system is *Triumvi*, a standalone, non-contact, circuit-level AC true power meter. *Triumvi* addresses the fundamental concerns of power metering: it is accurate (4.3% RMS error with loads of varying power factors), it minimizes installation complexity and requires no downtime (by clipping around a wire running to a breaker), it powers itself (by energy-harvesting), it calculates true power (by sensing current directly and voltage capacitively), and it is failure resistant (by calculating power on the meter itself). It achieves these goals with a core “triumvirate” of systems that supply power, measure AC voltage, and measure AC current without requiring direct AC mains contact.

Building out from the core meter, the system adds configuration and communication capabilities. Configuration modules allow the core sensor to operate in three-phase mode, in which each phase is measured simultaneously, to share charge, where two or more sensors can harvest energy collectively, and to leverage an external voltage signal, to increase accuracy. Additionally, the configuration module includes switches that allow the panel- and circuit-ID of the load to be “dialed-in” to facilitate quick and easy deployments. The communication module adds a wireless radio that is suitable for the target application. This could be IEEE 802.15.4 for data collection, Bluetooth Low Energy (BLE) for simple smartphone connectivity, or sub-1 GHz for longer-range industrial environments.

Realizing this design point requires revisiting the design options for each subsystem in a power meter, selecting the options or creating new approaches that are compatible with the deployability goals of the system, and carefully integrating the subsystems into a compact, scalable, and secure meter. It also requires understanding the limitations of existing solutions that hamper their use, and developing an expansion framework for the meter to support the wide range of deployment requirements present in different applications.

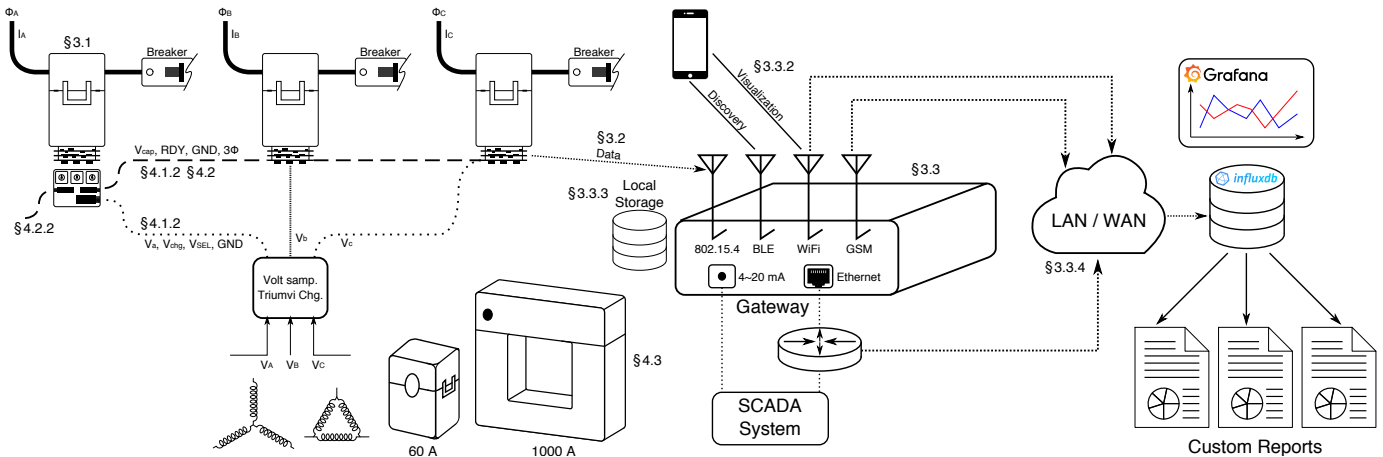

Fig. 1: System overview. Meters clip to wires exiting circuit breakers and harvest energy to power themselves, detect voltage phase, sample AC current, and wirelessly transmit true power measurements. Optionally, they share charge, measure synchronously, or use an external voltage signal or power source. The nearby gateway collects the measurements and publishes them to local users, existing BMS/SCADA systems, local storage, or cloud services. This metering system, which combines easy-to-install sensors that support flexible metering options, a versatile gateway, and cloud-hosted data management services, addresses the real-world needs and constraints that prevent broad adoption of existing power meters.

The Triumvi design emphasizes deployability and versatility while relaxing the need for revenue-grade accuracy—an acceptable trade for many non-billing applications. Prior approaches for panel-level metering also make trade-offs, typically by compromising on deployability. Commercial panel-level meters [5, 11] are quite accurate, but they require invasive integration into the panel box, often necessitate extensive installation labor, force downtime, and possibly entail panel box upgrade or replacement. Commercial energy-harvesting solutions [9, 10] are easy to clip around a circuit, but do not measure true power and exhibit significant error with non unity power factor loads. Magnetometer, hall-effect, and other electromagnetic field based approaches [22, 24, 27, 29] suffer reduced accuracy from crosstalk between circuits and consequently require runtime calibration. Gemini [15] requires a separate meter for voltage measurement and two current transformers—adding expense and bulk, and reduced robustness due to the meter’s distributed design.

Triumvi’s three systems allow it to overcome the limitations of prior power meters. It uses a non-contact capacitive coupling technique to measure the voltage signal, a clip-on current transformer to provide current measurements, and a multiplexing circuit to repurpose the current transformer as an energy-harvester to supply runtime power. The core metering operation adapts to any configuration extensions that are installed. If the core meter is in three-phase or split-phase mode, it waits until the meters on each leg of the load have harvested sufficient energy before synchronously taking a measurement across each phase. If the meter is in charge sharing mode, it will redistribute charge among the sharing meters to “charge up” strugglers—nodes on circuits with little or no load. If the meter has been provided with direct access to the voltage channel it will use that rather than its onboard sensor. These modular

configurations allow the same basic meter design to address a range of different application requirements.

The system’s modular design enables it to adapt to a variety of usage scenarios. The meters can be quickly installed in a panel box with small batteries for a short-term, diagnostic energy audit, and if further measurements are required the meters will automatically switch to energy-harvesting mode. Additionally, the meters can be upgraded to enable charge sharing across circuits or direct access to the voltage channel for increased accuracy. The system can also meter three phase loads, such as air handling units or industrial equipment, by synchronously taking measurements across the phases. For higher power loads, the meter core can be upgraded with a current transformer rated for higher current, and the other modules will continue to work. The result is a system that leverages the basic core design—non-contact energy-harvesting based metering—and can adapt it for a range of metering needs.

Our implementation demonstrates the effectiveness of this design by measuring three real-world AC circuits that draw 150 to 600 W with an average of 4.3% RMS error at a measurement rate of 0.3 Hz in a package just slightly larger than a standard clip-on current transformer. We also show that for loads with non-unity power factors, the Triumvi meter achieves seven times lower error than devices without access to the AC voltage channel, important for industrial applications. To further explore the efficacy of the system, we run three “energy audit” deployments of twelve Triumvi meters and find that the system can calculate energy with 3.7% error over a multiple day period. The combination of energy-harvesting, non-contact voltage capture, and current sampling, in a completely non-contact design, allows this power metering system to meet accuracy and reliability goals without runtime calibration while achieving deployability.

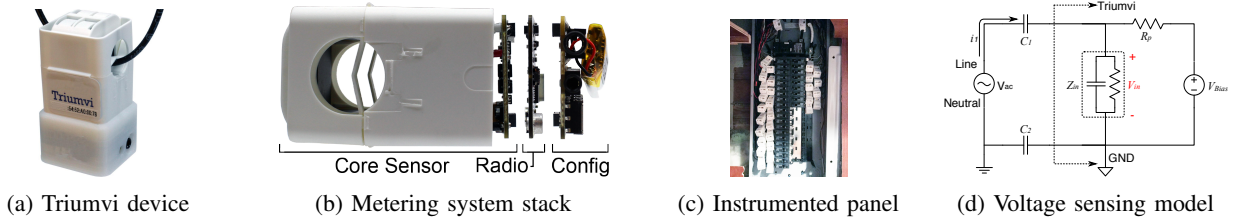

Fig. 2: Sensor implementation, composition, deployment, and equivalent circuit for non-contact AC voltage sensing.

II. SYSTEM OVERVIEW

The modular power metering system shown in **Figure 1** includes a core energy-harvesting power meter, a radio module, and a gateway. If needed, configuration modules can be added to extend the functionality. **Figure 2b** shows these modular components. When deployed, the meters are clipped around wires inside of a circuit-panel and they wirelessly transmit their measurements to a nearby gateway. The gateway collects these packets, can display them to local users, and optionally forwards them to the cloud for storage, processing, and visualization.

This system is designed for straightforward deployments as shown in **Figure 2c**. The installation procedure consists of 1) removing the front panel of the circuit panel, 2) dialing in the panel ID (0-F) and circuit numbers (0-99) on each meter, 3) clipping each meter around the wire to the correct circuit, and 4) plugging in a gateway nearby. No wires need to be connected, the main breaker can remain powered, and a 14 circuit install can be completed in less than a half hour.

III. DESIGN

Power meters can enable energy reductions and cost savings, equipment monitoring, and smart building applications, but a major barrier to adoption has been installation cost and complexity. Many of the design decisions for the components of this metering system are guided by an emphasis on ease-of-deployability, thus ensuring that the resulting system can be effectively used.

A. Non-Contact Meter

At the center of this system is the Triumvi energy-harvesting meter. Triumvi represents a new design point for power meters as existing designs make choices that complicate installations or reduce accuracy. True power meters have four essential requirements: energy to power themselves, measurements of the current and voltage channels, and a resulting power measurement. To avoid cumbersome wires and the need for mains power, Triumvi cannot rely on an external power source, and to avoid periodic maintenance it cannot depend on batteries. To obtain the current waveform, Triumvi avoids using Hall effect or magnetometer sensors that “stick-on” devices use because crosstalk from adjacent sensors requires a post-deployment calibration [22, 29]. To obtain the voltage channel, Triumvi avoids plugging into an unused breaker because of the added expense of hiring an electrician. However, Triumvi does not ignore the voltage channel (by reporting only current) so that it can calculate true power without compromised accuracy.

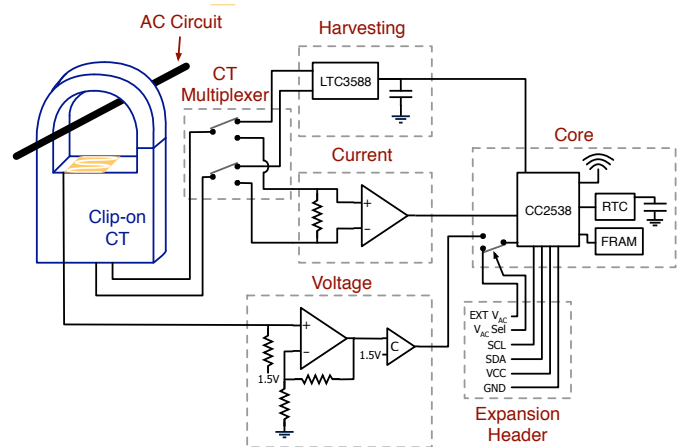

Fig. 3: Triumvi core meter design. The three main system components (harvesting, current, and voltage) use inputs from the split-core current transformer and voltage sense conductor to provide the processing core power, and scaled current and voltage signals, to compute core power. The core’s real-time clock (RTC) and low-energy memory (FRAM) can time-stamp and store data locally when the network is unavailable. An expansion header allows external voltages to be used (for the voltage channel signal or to power the meter, if higher accuracy or resolution is required).

To avoid these undesirable design options, Triumvi uses a split-core current transformer (CT) to harvest energy from the load it is monitoring, repurposes the CT to measure current, leverages a capacitive coupling circuit to sense voltage, and performs sample-by-sample multiplication of the two channels to calculate true power. These core systems are shown in **Figure 3**, and collectively they eliminate the installation challenges that existing designs present.

1) *Energy-Harvesting Power Supply*: The energy-harvesting power supply is responsible for powering the rest of the device. Harvesting is based on rectifying the output of a current transformer (CT) that is clipped around the AC phase line running to a breaker in a circuit panel. When the circuit is drawing current, the electromagnetic field it generates induces a current in the transformer, which is rectified and used to charge a bank of capacitors. This design extends previous work [15, 16] by not only using the CT for harvesting but also for measurement.

By harvesting energy to power itself, Triumvi avoids issues with other power sources. First, harvesting removes the need for the meters to be wired to mains power. This supply may be a breaker, which likely adds the expense of an electrician to install it, or a nearby outlet, which may not be available. Alternatively, the meters could be battery powered, which permits the standalone form factor, but imposes a constraint on lifetime and maintenance requirement.

The main drawback to energy-harvesting from the AC lines is that harvestable energy is proportional to load current, and as such there exists a minimum measurable load current. Two factors mitigate this issue: first, many loads are often aggregated on a single circuit, and second, low power loads are often not the point of interest for the deployment. Additionally, deployments can be upgraded to avoid this limitation by leveraging charge sharing between meters on high- and low-power circuits, which involves simply adding a wire between meters.

2) *Voltage Measurement*: Real-time access to the AC voltage channel is needed for power meters to accurately meter loads with non-unity power factors. Triumvi uses a novel capacitive voltage sensing technique in which a flat conductor is placed near the wire to be metered runs. This forms a capacitor between the sensing conductor and the wire.

Lorek et al. [22] used a similar design for monitoring voltage on the outside of the breaker itself, and demonstrated that this technique can accurately measure voltage with about 1% error. However, their measurement technique requires calibration, as the geometry of the breaker, the layout of the sensing device, and the installation placement all affect the measurement. In Triumvi's case, we only extract voltage phase to avoid calibration. Figure 2d shows an equivalent circuit model of the Triumvi voltage sensing circuit which we can use to derive an equation for V_{in} :

$$V_{in} = V_{ac} - i_1 \times (1/j\omega C_1 + 1/j\omega C_2) \quad (1)$$

$$V_{in} = (i_1 + (V_{Bias} - V_{in})/R_P) \times Z_{in} \quad (2)$$

$$i_1 = \frac{j\omega C_1 C_2 (V_{ac} - V_{in})}{C_1 + C_2} \quad (3)$$

$$V_{in} = \frac{Z_{in}(i_1 + V_{Bias}/R_P)}{1 + Z_{in}/R_P} \quad (4)$$

$$V_{in} = \frac{V_{Bias} Z_{in} (C_1 + C_2) + j\omega C_1 C_2 V_{ac} Z_{in} R_P}{(R_P + Z_{in})(C_1 + C_2) + j\omega C_1 C_2 Z_{in} R_P} \quad (5)$$

Noting that $C_1 \gg C_2$, we can approximate by:

$$V_{in} \approx \frac{V_{bias} + j\omega C_2 V_{ac} R_P}{1 + R_P/Z_{in} + j\omega C_2 R_P} \quad (6)$$

$$V_{in} \approx \frac{Z_{in}}{Z_{in} + R_P} \times (V_{bias} + j\omega C_2 V_{ac} R_P) \quad (7)$$

Because V_{in} depends on C_2 , by measuring V_{in} we cannot solve for V_{ac} to extract the true AC voltage signal. However, this does provide enough information to extract the phase.

From the phase information, Triumvi assumes a sinusoidal voltage signal at the nominal voltage amplitude. Prior work has shown that the voltage signal remains largely sinusoidal even

when supplying large loads [15, 26]. Amplitude, however, does vary over the course of a day, although the resulting error is substantially less than the error resulting from ignoring voltage phase information.

As with the current measurement, this method of acquiring voltage is the only viable option for Triumvi. The traditional method, direct contact, is not feasible given deployment constraints, and virtualization of the signal (as in Gemini [15]) is undesirable because it adds an additional failure point, could lead to a flooded wireless channel, requires matching the circuit to the correct voltage phase, and may be impossible to deploy in some industrial contexts.

3) *Multiplexing the Current Transformer*: Triumvi uses a single current transformer (CT) for both the power supply circuit and current measurement. Triumvi is able to selectively insert a burden resistor across the CT inputs to facilitate accurate, point-by-point sampling of the current channel. Balancing harvesting and measurement requires careful design of the circuit that switches between the two modes. Simply inserting FETs between the CT and burden resistor is insufficient as the CT output voltage can be too high to reliably enable or disable the FETs, causing leakage that prevents harvesting or affects current measurements. Instead, our design completely cuts off the burden resistor when harvesting.

Triumvi's ability to multiplex the current transformer is critical for the meter to achieve its goals, as no other options for acquiring the current signal are sufficient. Using a second CT—one for harvesting and one for sampling—would make the device too large to easily install, and would add cost. Using a shunt resistor requires direct contact with the circuit, and using a hall effect sensor (or similar) to detect the electromagnetic field would reduce accuracy and impose a calibration step. Therefore, the Triumvi design requires a multiplexing circuit, even though it can introduce a small burden on the CT signal.

4) *Additional Meter Functions*: The Triumvi meter includes several additional support functions to enable flexible and robust deployments. First, a real-time clock (RTC) powered by a re-chargeable supercapacitor keeps local time, enabling locally stored, timestamped measurements that allow gateway-less operation. Having a sense of time also allows the meter to calculate energy, which can mitigate the effects of dropped packets as well as provide interval metering. Second is a reset button which allows a user to reset the internal energy accumulation if the meter is moved between circuits. And third, the meters can calculate power factor by dividing their power measurements by the product of RMS current and voltage.

B. Wireless Communication

Triumvi meters can wirelessly transmit their data for collection by adding a radio module, and the radio can be chosen to match deployment requirements. The requirements for the radio are minimal—it must be able to transmit a packet to a nearby gateway. Due to the energy-harvesting and limited onboard energy storage, however, the radio must be able to transmit a packet while consuming only the minute amounts of energy available through harvesting.

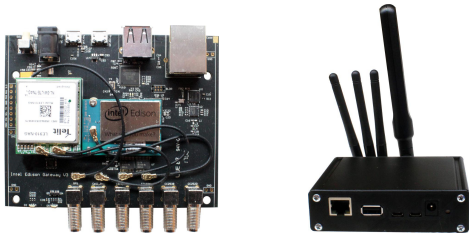

Fig. 4: Gateway hardware. The gateway contains a dedicated radio for receiving Triumvi packets and additional radios (WiFi, BLE, and cellular) for transmitting the data.

C. Gateway Services

Each meter expects an always-on gateway, shown in Figure 4, within range to receive measurement packets as scheduling transmissions under harvesting uncertainty is not always possible. Additionally, the gateway also provides current time to the meters, logs power data locally, forwards packets to the cloud, retransmits data for local “walk-up” access and spot-checks, and host a webpage showing the current state of all circuits.

1) *Timestamping*: To set (or reset) its internal RTC, the Triumvi node sends a time request packet to the gateway which immediately responds with the current time. Due to the limited runtime afforded by the energy harvesting power supply, the gateway must respond in 2.5 ms or less to ensure the Triumvi is awake to receive the packet. To enable this, the gateway design includes a dedicated co-processor with direct access to the wireless radio to ensure low-latency responses. The co-processor keeps time by periodically querying the main gateway processor (which uses NTP) for the current time and then using its internal clock to track time between updates.

2) *Decoupling Data from Wireless Radios*: Wireless radios trade off power, range, bandwidth, and interoperability. For the Triumvi meters, the radio that is best for transmitting to the gateway is likely not ideal for getting the power data to a smartphone, which might be necessary for local monitoring or on-site energy diagnostics. To decouple the data from the wireless radio on the meter, we use the gateway as an intermediary. For example, a technician can retrieve the power draw of the equipment they are servicing over Bluetooth Low Energy, and view it using a smartphone. This eliminates the need for the technician and gateway to be on the same network, or for the meters to use a radio the smartphone supports.

3) *Local Data Storage*: In certain deployment scenarios, network security, data privacy concerns, or network unavailability may prohibit the gateway from connecting to the Internet. In these cases, the gateway can log data to an internal database and the data can be downloaded as a CSV file directly from the gateway for offline processing.

4) *Cloud Data Offload*: In the more common case, the gateway can offload the collected data to a cloud backend for storage and processing. The gateway software stack is architected to support arbitrary endpoints and databases. For network bandwidth reasons all cloud forwarders on the gateway batch readings before sending them to the cloud.



(a) Config Board (b) Expanded Meter (c) High Current Meter
Fig. 5: Triumvi configuration board and high current version.

IV. DEPLOYMENT AND USAGE CONCERNS

A major portion of the power metering system design supports a wide variety of deployment scenarios. No previous metering system is flexible enough to support this wide array of potential applications.

A key aspect of this is an optional configuration expansion board, shown in Figure 5a, that exploits the structured nature of panel boxes and includes three knobs for setting the panel ID and circuit number to which the Triumvi meter is attached. When these are set, each meter tags its data packets with the measured circuit number and panel box ID. This removes the cumbersome step of manually recording and later entering the meter-to-circuit mapping. It also simplifies all future data processing as services, such as the walk-up gateway and backend data analytics, do not need to maintain their own device mappings. Pushing this metadata directly onto the deployed devices not only makes the deployment easier, but also promotes flexibility when creating applications on top of the data stream.

A. Residential and Commercial Buildings

A primary use case for circuit-level power metering is instrumenting residential and commercial buildings to identify potential energy savings or improve building operation.

1) *Energy Audits and Exploratory Research*: Energy audits are used to establish a baseline energy profile for a building with power meters deployed for 24 hours to a week. In a residential setting this may be sufficient to identify misbehaving or inefficient loads. In a commercial building, short deployments and the ability to move the sensors between panels provide insight on whether to pursue long-term monitoring. In either case, the substantially easier installation of this system makes these deployments feasible, whereas existing meters require too high of an upfront cost (whether in hardware, installation, or calibration) to justify preliminary exploratory research of energy consumption.

2) *Upgrades for Proven Deployments*: Because of the flexibility in the system design, the meters can be upgraded *in situ* if a trial deployment proves successful and the additional labor cost is justified. This progressive approach is a substantial departure from other systems that require the entire cost to be borne up front.

The first upgrade involves providing power for the sensors to enable a more reliable sampling interval without replacing or reinstalling the existing meters. One option for this is to

enable charge sharing between Triumvi meters with a short jumper cable that bridges the harvesting capacitor banks of two meters so that each harvester is charging the cumulative energy store. This allows a meter with a higher harvesting potential to subsidize other meters. Another option is to provide an external power supply for the meters and daisy-chain the power supply wires between the meters.

The other option for an in situ upgrade is providing the voltage channel information externally to each meter. This too does not require removing or replacing the existing meters and enables higher accuracy when calculating power. To implement this option, wires are connected to an unused breaker, run to a combined power supply and voltage isolation circuit, and then daisy-chained to each installed meter.

B. Three Phase Loads

Many loads in a building are not single-phase loads. For instance, electric stoves, HVAC equipment, and industrial motors are all split-phase or three phase loads. Accurately metering multiple phase loads requires taking simultaneous measurements across all phases of the load. To enable synchronized sampling, two or more Triumvi meters can be wired together into a Wired-NOR configuration. While the meters are charging, they each use their storage capacitors to pull the shared line high. When each meter is charged and ready to take a measurement, it pulls the line low through a diode. When all connected meters have done this, all of the nodes will see the line go low and proceed with their power measurement in a synchronized fashion.

C. Large Loads

Metering and monitoring large industrial equipment (in the range of 20 to 1000 A), such as arc furnaces, water pumps, and large motors, can enable peak-demand shaving and equipment fault detection, but the same meter cannot be used for residential-scale loads and these large consumers. To demonstrate that the metering approach can scale to larger loads, we develop a Triumvi meter that can support up to 1000 Amps (Figure 5c). The meter design scales while only requiring changes to the biasing resistors for the amplifier circuits. The larger range also enables a function that is difficult on the smaller meter: battery recharging. Due to the higher load currents, the Triumvi meter can recharge its onboard battery to permit higher sampling rates or sampling while the metered load is off.

D. Detailed Load Analysis

Some applications require more insight than just power or power factor, and actually need the raw AC current waveform for more advanced power analysis or power quality monitoring. Our system supports these applications by transmitting the raw current waveform samples when requested. Each Triumvi meter is able to collect and transmit samples of the current waveform for an entire AC cycle (a total of 120 samples) on each activation.

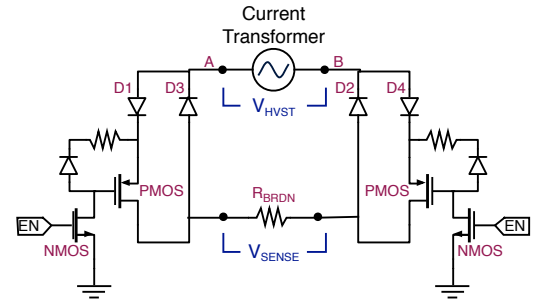

Fig. 6: Current transformer multiplexing circuit responsible for switching the CT between harvesting and measurement operation. When EN is high, the NFETs connect the inputs of the CT across R_{BRDN} through diodes D1-D4 and enable current sampling. When EN is low, the PFETs stay off and harvesting is enabled. Multiplexing the current transformer is essential for saving size and cost by requiring only a single CT.

V. IMPLEMENTATION

Triumvi’s implementation centers on the core Triumvi hardware and operation.

A. Triumvi Meter

The energy-harvesting circuit is based on the LTC3588-1 [6] and prior work [15, 16]. The LTC3588 rectifies the incoming signal from the SCT-16A CT [3] and uses 660 μF of capacitance for energy storage and an additional 100 μF capacitor for output buffering. The output of the harvester feeds a 3 V LDO for powering the rest of the system.

When Triumvi is taking a measurement and must switch the CT into measurement mode, the CT multiplexing circuit (Figure 6) is responsible for applying a burden resistor across the inputs of the CT. Importantly, it must also completely disconnect the burden resistor when harvesting. The mode of the CT is set using the EN line. When EN is high, the CT is in measurement mode, and when EN is low the harvester is operational. In harvesting mode, EN being low turns off the NMOS FETs, causing the gate of the PMOS FETs to float to the same voltage as the input from the CT, causing the PMOS FET to be off. This disconnects R_{BRDN} from the CT as the only remaining path through D2 and D3 is blocked by the diodes. When EN is high, the NMOS FETs are on, pulling the gates of the PMOS FETs low and enabling the PMOS transistors. This completes a path for current to flow through R_{BRDN} . During half of the AC cycle when point A is at a higher voltage than point B, current flows through D1, across R_{BRDN} , and then through D2. During the other half of the cycle the opposite happens, as current flows through D4 and back through D3. In measurement mode, the harvesting circuit is still connected, but the introduction of R_{BRDN} causes the input voltage to be too low, effectively disabling the harvesting circuit.

B. System Operation

Triumvi’s operation follows three main steps: setup, measurement, and report. An example trace of this operation is

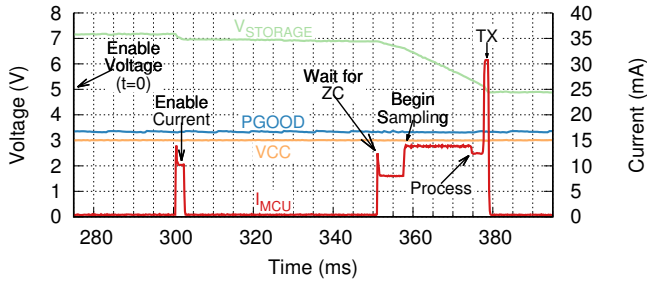

Fig. 7: Current and voltage trace of a Triumvi measurement. The voltage on the storage capacitor, PGOOD, VCC, and the current draw of the microcontroller are shown while Triumvi measures power. At the start (not shown) Triumvi enables the voltage measurement circuit and waits 300 ms. It then enables the current measurement circuit before waiting for a rising zero-crossing of the AC voltage signal to start sampling the current for 16.6 ms. After, it computes power, encrypts, and transmits the measurement.

shown in Figure 7. The device starts in harvesting mode and charges the storage capacitor until it has accumulated enough energy to perform a measurement. When this threshold has been met Triumvi first enables the voltage measurement circuit and allows it to stabilize for 350 ms. Next, the system enables the current measurement circuit—which disables harvesting—and again waits for 50 ms for stabilization. With these enabled, Triumvi begins sampling the current waveform after the next rising zero-crossing of the voltage signal, which synchronizes the two signals. After sampling for one AC cycle at 7.2 kHz, Triumvi disables the voltage and current measurement circuits and begins computing power using a factory calibrated sine wave for the voltage signal. When the result is ready, it AES encrypts and wirelessly transmits the payload using an IEEE 802.15.4 radio. The computation, encryption, and transmit phase takes 4.34 ms, and the entire measurement and report takes 380 ms and uses 1.7 mJ.

VI. EVALUATION

We evaluate the metering system based on the performance of the core meter, the effects of the configuration options, the accuracy of the overall system, and the deployability of the end-to-end system.

A. Voltage Sensing

The voltage sensing circuit that tracks the phase of AC voltage has some phase error inherent to the circuit. Figure 8a shows the distribution of phase error. To measure this, the position of the AC wire inside of the current transformer was fixed, and the output of the comparator was compared against the ground truth AC voltage zero-crossings. After subtracting a fixed 148.4° phase error, the resulting jitter error is low, with a standard deviation of 0.7° .

As the AC line and the conductor are capacitively coupled, the spacing and orientation of the two conductors relative to one another affects the phase estimation. We re-run the

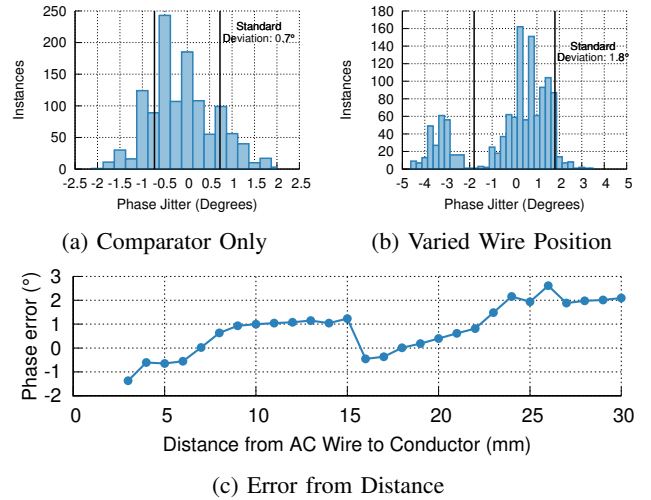

Fig. 8: Voltage sensing phase error. Figure 8a shows the distribution of phase error of the voltage sensing circuit when the AC line is in a fixed position inside of the CT. In Figure 8b, the same distribution is plotted but the wire is moved inside of the CT. While the placement of the wire relative to the voltage sensing conductor affects the phase error, the standard deviation of the error remains low at only 1.8° . Figure 8c shows the error as a function of distance between the conductor and AC wire, and in the range that is possible for the Triumvi CT (up to 18 mm), the phase error is capped at 1.5° .

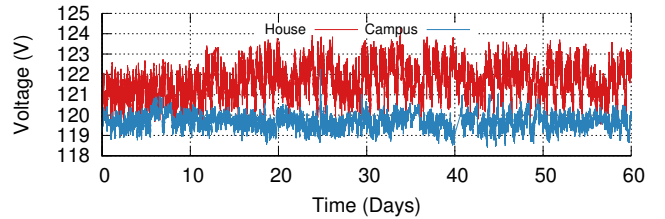

Fig. 9: RMS voltage over two months in two locations. While RMS voltage does fluctuate over time, the swings are typically 5 V or less. Triumvi assumes a nominal voltage amplitude, causing up to 5 V error under normal conditions.

previous experiment but do not keep the wire in a fixed location. Figure 8b shows the resulting distribution. The phase error increases, but is still low with a standard deviation of 1.8° . This holds when the AC line and sensing conductor are separated by a gap of at least 3 mm, which we ensure by locating the conductor inside of the current transformer case.

We also observe the effect of distance on the voltage phase measurement error. Figure 8c shows the error as a function of the distance between the AC wire and the conductor. We see similar results with the error remaining under 1.5° in the range possible for the Triumvi CT (up to 18 mm).

Without runtime calibration, the capacitive coupling voltage sensing technique is unable to accurately measure the amplitude of the voltage signal. Therefore, we assume a nominal voltage when calculating power. Figure 9 shows the RMS voltage of

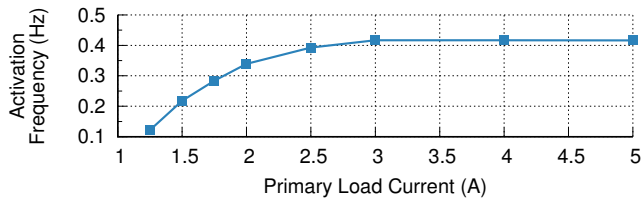

Fig. 10: Activation rate as a function of primary load with power factor of 1.0. Below 1.25 A, the meter is unable to harvest enough power to measure, but at 3 A it can sample at nearly 0.5 Hz.

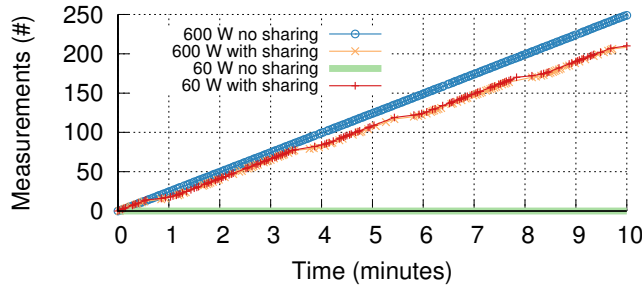

Fig. 11: Example of charge sharing between meters on a 600 W load and a 60 W load. The meter on the higher load drops from a sample rate of 0.42 Hz to 0.35 Hz, but by sharing its charge the meter on the 60 W load goes from being unable to charge to a sample rate of 0.35 Hz. Charge sharing is an effective way of mitigating the minimum load requirement of energy-harvesting without requiring battery or mains power.

two circuit panels over two months. The RMS voltage fluctuates, but is capped to about a 5 V swing under normal conditions, which is consistent with previous findings [22]. For Triumvi, this will cause up to 2.8% RMS measurement error.

B. Sample Rate and Measurement Range

The main limitations of energy-harvesting are its impact on the activation rate and the minimum measurable load of the meter. We evaluate Triumvi’s measurement rate by sweeping over a range of primary loads and recording the update rate of Triumvi. Figure 10 shows the results. With a primary load above 3 A, Triumvi is able to measure at 0.41 Hz. Below 3 A the update rate is slower, and below 1.25 A the meter is unable to harvest enough energy to complete a measurement (when the load has a power factor of 1.0). When loads have non unity power factors, the current signal tends to have higher peaks, providing a high enough input voltage for Triumvi to harvest and allowing Triumvi to work at lower load wattages.

While this minimum prevents the system from being able to measure small loads, circuits typically contain multiple loads, resulting in a higher aggregate. For some approximate context, a common desktop computer draws about 75 W, a refrigerator draws about 150 W, and a home central air conditioning unit draws about 3500 W.

One method of mitigating the effects of a minimum meterable load is to use charge sharing between two or more meters. Because the meters rate limit their transmissions, sharing often has minimal effect on the meter that is attached to the higher power load. To demonstrate, Figure 11 shows the measurements a meter attached to a 600 W load is able to take with and without charge sharing. After charge sharing, its measurement rate drops from 0.42 Hz to 0.35 Hz. However, the meter on a 60 W load that is completely unable to sample without charge sharing, is also able to sample at 0.35 Hz with the assistance of the first meter. Using charge sharing is an effective method to overcome energy-harvesting’s limitations.

C. Power Meter Accuracy

We observe the system’s accuracy in both real-world contexts and compared to current-only meters.

1) *Real World Loads*: To evaluate the accuracy of the overall power metering system, we meter three real-world circuits and compare with a ground truth meter. The traces, shown in Figure 12, reflect circuits likely found in three different building types: office, residential, and industrial. Over all three traces, Triumvi provides power measurements with 4.3% RMS error when the meter is able to harvest and take samples. The error comes primarily from an offset present during the steady-states in Figure 12a and Figure 12c and from spikes when the load suddenly changes. Triumvi must continue harvesting until it is able to measure and detect the change in load power.

For all three circuits, the power factor is always less than 1.0. Even with the aggregation of many loads, some containing power factor correction, real-world circuits do not have unity power factors and calculating true power is essential for accuracy. While our system’s accuracy is slightly lower than commercial-grade panel meters, it is not intended to provide revenue-grade metering and some error is acceptable for the submetering problem. However, in non-ideal cases (non-unity power factor loads) without the ability to calculate true power, the error would grow beyond an acceptable range.

2) *Comparison with Current-Only Meter*: Our system achieves accurate measurements for loads with non-unity power factors because it can properly phase align the voltage and current waveforms. To compare this performance with a similar, but current-only meter, we use both Triumvi and the Pressac CT device [10] to measure loads ranging from 150 W to 950 W. Each load has a power factor of 0.85, which approximately matches the real-world conditions from Figure 12. Power for the Pressac device was calculated by multiplying its RMS current readings by RMS voltage. Figure 13 shows the output of the two devices and the RMS error of each measurement. Through most of the measured range, Triumvi has significantly lower RMS error than the current-only Pressac CT. Using the voltage signal is essential for maintaining accuracy across a wide range of deployment scenarios.

To further investigate the effect of having voltage phase information on power calculations, we run Triumvi again with loads ranging from 150 W to 950 W and power factors of 0.85. The meter reports both power and RMS current which is later

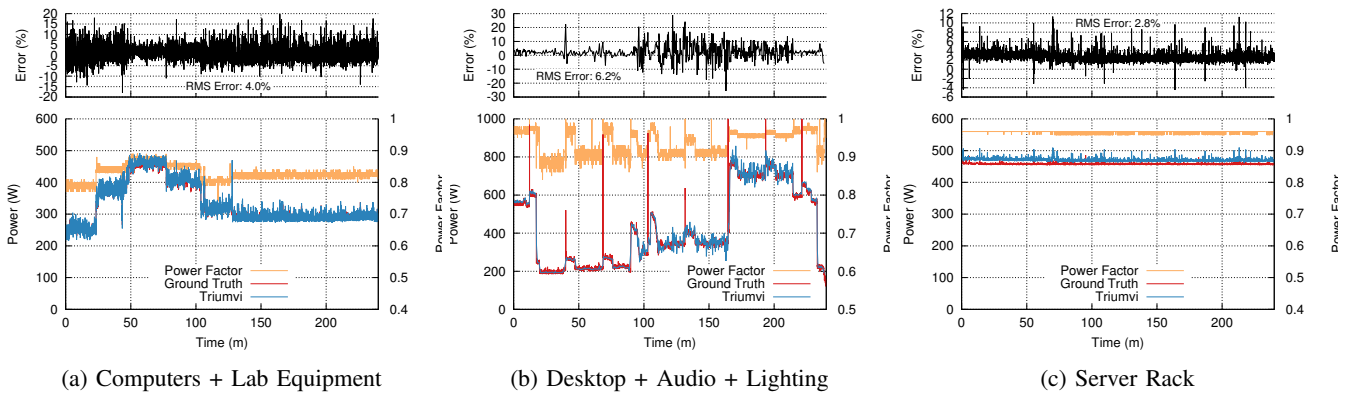

Fig. 12: Triumvi accuracy with three real-world circuits. Triumvi is compared against ground truth for three circuits representative of three different environments where circuit panel meters may be deployed. The circuit in Figure 12a contains two desktop computers, four monitors, and various lab equipment, as may be present in an office building. Even with a power factor consistently below 0.9, Triumvi is able to meter the circuit with 4.0% RMS error. Figure 12b shows a circuit with LED lighting, a desktop computer, and a refrigerator, as may be present in a residential setting. Overall RMS error is 6.2%. The third circuit, Figure 12c, contains a rack of servers as may exist in a more industrial setting. The servers are a very constant load which Triumvi overestimates but otherwise tracks well. For that circuit, Triumvi displays only 2.8% RMS error. These traces demonstrate Triumvi’s ability to meter real-world circuits.

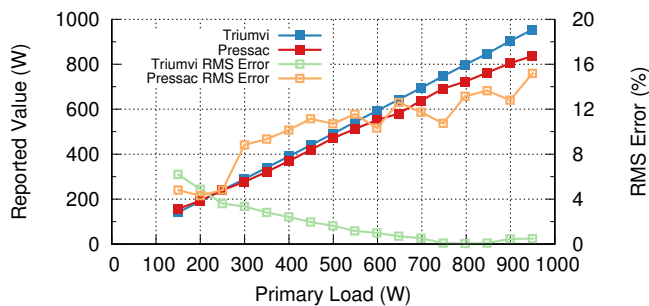

Fig. 13: Comparison with the Pressac CT current meter [10] over a range of 0.85 power factor loads. Power for the Pressac device is calculated by multiplying the reported RMS current values by RMS voltage. Above 250 W, Triumvi’s error is significantly lower than the Pressac device. With non-unity power factors, calculating true power is critical for obtaining accurate power measurements.

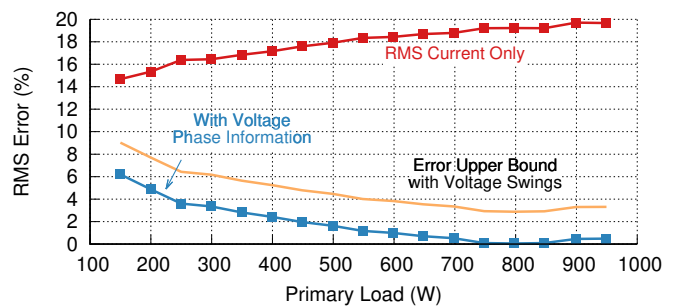

Fig. 14: Error with and without voltage phase information. For a range of loads with power factor of 0.85, the RMS error of Triumvi’s power measurement using only RMS current and using sampled current plus voltage phase information is shown. Without any voltage information the error averages 18.5% RMS, and with phase information the average error is 2.5% RMS.

multiplied by RMS voltage. The RMS error of these power measurements is shown in Figure 14. The RMS error over the range is on average seven times lower when computed with voltage phase information instead of using just RMS current. While it can measure phase, the Triumvi design assumes a constant voltage amplitude. The resulting upper bound error from the voltage fluctuations described in Section VI-A is also shown in Figure 14. This error is significantly lower than the error caused by no voltage information.

3) *Power Factor Measurement*: The core Triumvi meters report power factor in addition to power and current. We test Triumvi on loads with power factors from 0.7 to 1.0 due to phase shifts between voltage and current, and with power factors from 0.3 to 1.0 due to high crest factors in the current waveform.

For most common loads that have a power factor greater than 0.7, this error is under 5%. Only when the waveform is heavily distorted (power factor below 0.5) does this error grow above 5%, but loads with such low power factors are very uncommon.

4) *Current Waveform Accuracy*: We compare the raw current waveforms sampled and reported by the Triumvi meters with ground truth waveforms and show the comparison in Figure 15. Triumvi is able to collect 120 measurements per cycle and wirelessly report the samples with less than 4% error. These raw waveforms can then be processed offline for power factor analysis, power quality monitoring, or fault identification.

D. Deployments

A primary goal of this metering system is to be deployable, and we evaluate installation time, three real-world energy audit

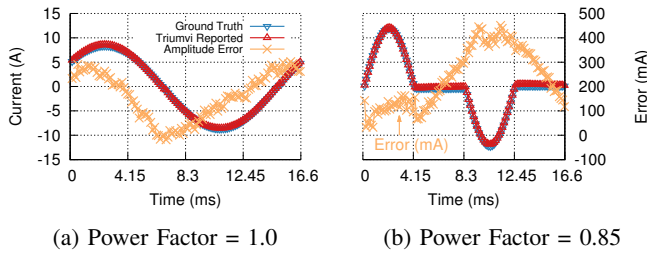

Fig. 15: Sampled current waveform as reported by the Triumvi meters for two different power factor loads. Triumvi is able to report raw waveforms with less than 4% error.

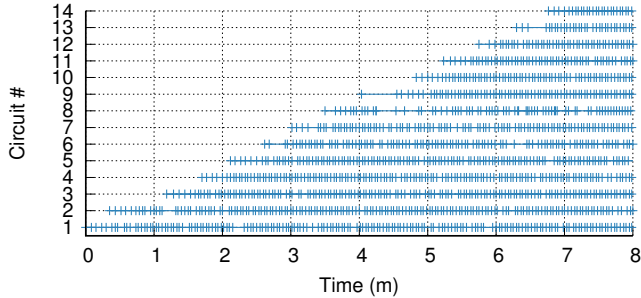

Fig. 16: Installation time for 14 circuits. As Triumvi devices are configured with the panel ID and circuit number, and clipped around the correct circuit, they begin transmitting measurements. Each mark represents a received packet. Based on the start time of the circuit #14, installing 13 meters took about seven minutes for a familiar, but inexperienced user. Overall, we expect deployments to take a half hour or less.

deployments, and an industrial use case.

1) *Installation Overhead:* In Figure 16 we measure how long it takes to install 14 clip-on meters. Each mark indicates a received packet and each sequence starts when the meter is installed. The interval between the start of each line is approximately 30 s, and the installation takes about seven minutes. Factoring in overhead for accessing the panel, an average deployment can be completed in less than a half hour. Whereas other systems require disruptive installations (turning off power) or include long lead times (hiring an electrician), Triumvi’s installation costs are low enough to make the system feasible for a one-day or one-week deployment.

2) *Circuit-level Energy Breakdown:* We performed three energy audits to evaluate the end-to-end deployability of the system. For three homes, we measure eight circuits plus the aggregate over approximately 2.5 days, and compute the energy each circuit consumed. For ground truth data, we use an eGauge EG3000 meter [5]. Figure 17 shows the results. Overall, our system displays 3.7% error when measuring energy. Most of the error is from underestimating the actual energy use, which may be attributable to our prototype using a CT rated for 100 A which has low accuracy for very low primary loads. A larger toolkit of core Triumvi devices scaled for different amperage circuits may address this issue.

This audit shows that circuit 6 in home 1, which is responsible for most of the energy consumed in the test, may require additional submetering. This type of insight could be quite valuable for targeting submetering to reduce costs (e.g. metering a 13th circuit with eGauge requires purchasing an additional control unit).

3) *Industrial Use Case:* We deploy three Triumvi meters in the power panel of a large, three-phase municipal water pump for a period of three months. Figure 18 shows a snapshot of the collected data where Triumvi identified an irregularity in the phase balancing, which can be detrimental to pump health, before and after it was remedied. Overall, we collected 4,046,215 measurements, or 88.4% of the samples taken by the three meters. The 90th percentile packet interval is 2.46 s when the pump is active, matching what we expect from Section VI-B. The maximum packet interval is 1,670 s, occurring when the pump was off. The number of consecutively dropped packets is low, with the 99.9th percentile being only five dropped packets. This deployment demonstrates that Triumvi is effective at monitoring industrial equipment, and even though packet loss does occur, the effective sample rate is still 0.4 Hz with minimal missing periods when the pump is active.

E. System Properties

We also evaluate encryption cost, radio performance, and monetary cost of the metering system.

1) *Encryption Energy:* Encrypting the payload containing the power measurement provides a layer of privacy for the power data, but incurs an energy cost to perform the encryption. For a TI CC2538 microcontroller [12], performing an AES operation takes 84 μ s and consumes 10.2 μ J at 3 V, or 0.6% of the energy consumed during a measurement event.

2) *Radio Transmission:* Panel-level circuit meters operate inside of a metal circuit panel box—not an ideal environment for RF communications. To study the effects of this on packet reception, we place two low power 2.4 GHz beacons inside of a circuit panel box and one on the outside. From a receiver placed at varying distances directly away from the panel box and with a 90 degree angle with respect to the box, we measure packet reception rates. Figure 19 shows the ratio of packets received from the inside transmitters to the number from the outside beacon. As expected, the results vary widely, but do indicate that receiving packets from transmitters inside of panel boxes is viable. Also, as expected, placing the receiver near the panel box (1 m or closer) yields the greatest packet reception.

3) *Meter Cost:* With any power meter, if the cost of metering is higher than the expected benefit, the meter is not viable. While the retail cost of a prototype is difficult to determine, the hardware cost of any current transformer based meter is largely dominated by the current transformer (\$7.00 for Triumvi). The cost of circuit level power meter is not just its retail cost, but also its installation cost. With this system, even if the hardware cost is greater than other designs, avoiding the need to disconnect power and hire an electrician will render it with a lower overall deployment cost.

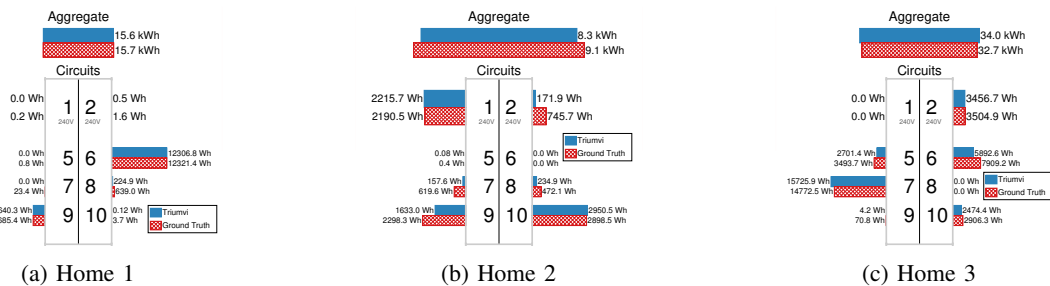

Fig. 17: Short-term deployments in three homes. The energy consumed by each circuit and the aggregate was measured over the course of approximately 2.5 days. Across all of the circuits, our system shows an error of 3.7%. This level of accuracy is sufficient for energy audits, and is capable of providing insight on where additional metering may be warranted.

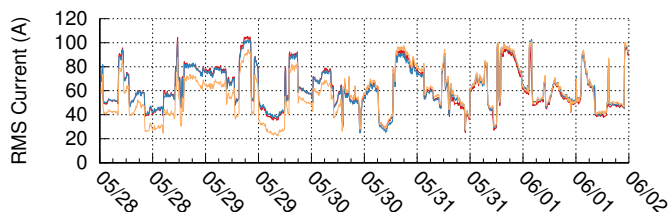

Fig. 18: Triumvi measurements of a large water pump. The 1000 A Triumvi variant with 3-phase synchronized measurements meters a municipal water pump for five days. The load phases were unbalanced and subsequently fixed, and Triumvi correctly detected this as confirmed by the water utility.

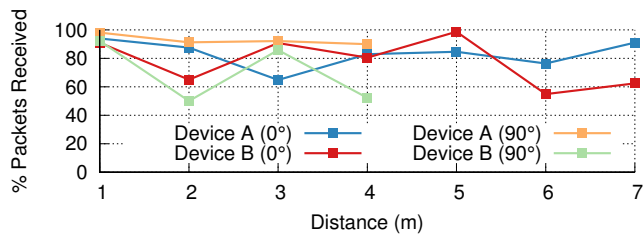

Fig. 19: Radio packets received from two 2.4 GHz transmitters inside a panel box compared to one outside. Even with the detrimental effects of the metal panel box on the RF signals, packets can be successfully received outside of the box.

VII. DISCUSSION

In this section we discuss limitations to the system and some potential solutions, as well as possible future improvements.

A. Voltage Measurement

Without runtime calibration, capacitive voltage sensing does not provide amplitude information as even small variations in the placement and orientation of the AC wire running through the current transformer produces different output values. However, it may be possible to identify the nominal voltage as typical AC voltages fall into discrete bins. Another approach may be to provide hints from the nearby gateway. If the gateway can monitor the local voltage channel it could periodically notify each Triumvi with updated voltage information.

B. Insufficient Harvesting Detection

If Triumvi detects that it is unable to harvest enough energy to perform a measurement, it could instead use the energy it does have available to transmit a packet announcing that it is unable to harvest. This would allow the gateway to distinguish between a low power load and a faulty sensor and provide more reliability in the energy-harvesting sensor.

C. Energy Analytics

Successful power metering deployments require analytics such as fault detection, measurement and verification, and energy saving recommendations. Many proprietary systems purport to provide these features, but we are unaware of an open-source tool that can accept data streams from a variety of meters and provide an interface for building managers to analyze and improve their buildings. A system with these features would not only enhance our system, but virtually every other power meter as well.

VIII. RELATED WORK

Power meters trade off accuracy, installation cost, submetering granularity, and complexity. This broad tradeoff space has encouraged many designs, including plug-load, circuit-level, and energy-harvesting options.

A. Plug Load Meters

Providing the finest metering granularity, but at the expense of requiring extensive deployments to provide sufficient metering coverage, plug load meters measure individual devices. Typical plug load meters [2, 13, 17, 21] sit between the device's plug and the wall and meter directly. Others [25] use a distributed set of sensors at each load to help disaggregate the total. In both cases, however, the required deployment densities and administrative overhead reduce deployment practicality.

B. Circuit Level Meters

Metering at the circuit level balances resolution with sense points. Comprehensive commercially available circuit panel meters, such as the large and expensive Siemens SEM3 solution [11], require invasive installations by an electrician and may require replacing the panel to accommodate the metering hardware. More compact solutions, such as the eGauge

EG3000 [5], Neurio W1-HEM [7], and Efergy Elite 4.0 [4], also require invasive installation, only support a handful of circuits, and do not scale beyond household use.

1) *Current-Only Meters*: One proposed device design for minimizing installation invasiveness is a “stick-on” device that attaches to the outside of each breaker. These magnetometer [24] and giant magneto-resistive [27] based approaches measure current based on the electromagnetic field near the breaker, but often have no access to the voltage channel and cannot measure true power. Further, they require wall power or frequent battery changes to provide system power.

Energy-harvesting approaches such as the stick-on piezo-electromagnetic device [29] or the current transformer-based Monjolo [16] devices monitor current while also powering themselves. Both of these devices, however, require runtime calibration. Two commercial solutions, the Pressac CT [10] and the Panoramic Power PAN-10 [9], are CT based energy-harvesting current meters. All of these devices lack the voltage channel, however, and cannot calculate true power—something that is important in many three-phase industrial applications.

2) *True Power Meters*: Newer circuit level meters have added voltage sensing and can calculate true power, while maintaining low installation overhead. The PASEM device [22] is a stick-on meter that uses a capacitive coupling technique to sample the voltage channel and a hall effect sensor for current. The device still requires runtime calibration to mitigate installation variances and crosstalk between circuits, an associated computer to process the sampled data, and wall power, however. Gemini [15] uses a CT and obtains voltage through a virtualization method [26] where voltage is sampled in a single location and, with tight time synchronization, wirelessly transmitted to each circuit meter. Gemini also leverages energy-harvesting to power itself, but requires an additional current transformer, increasing size and cost, and fails to meter entirely if connection to the voltage monitor is lost.

IX. CONCLUSIONS

We show that it is possible to build a flexible, standalone, energy-harvesting, true-power meter in a minimum form factor. This design addresses the U.S. DOE Low-Cost Wireless Meter Challenge with a Pareto-optimal design point, offering simple installation procedures, high measurement accuracy, secure data transfer, and affordable energy metering—paving the way to better building energy characterization and curtailment, and many new applications that require energy data in the industrial sector, including peak demand shaving, equipment fault detection, inexpensive energy audits, and verification of power factor correction.

X. ACKNOWLEDGMENTS

This work was supported in part by the TerraSwarm Research Center, one of six centers supported by the STARnet phase of the Focus Center Research Program (FCRP), a Semiconductor Research Corporation program sponsored by MARCO and DARPA. This material is based upon work partially supported by the National Science Foundation under grant CNS-1350967, as well as by generous gifts from Intel and Texas Instruments.

REFERENCES

- [1] Department of Energy (DOE) Buildings Energy Data Book. <http://buildingsdatabook.eren.doe.gov/>, 2012.
- [2] Belkin WeMo Insight. <http://www.belkin.com/us/p/P-F7C029/>, 2017.
- [3] DERE Split Core. <https://www.dere.com.tw/split-core-c-t.htm>, 2017.
- [4] Efergy Engage. <http://efergy.com/us/engage-elite-hub-three-phase>, 2017.
- [5] eGauge EG3000 Meter. <http://egauge.net/products/EG3000/>, 2017.
- [6] LTC3588. <http://cds.linear.com/docs/en/datasheet/35881fa.pdf>, 2017.
- [7] Neurio Energy Monitor. <https://www.neurio.com/energy-monitor/>, 2017.
- [8] Obvious Power Panel+. <http://www.obvious.com/Products/PPP-O-XX>, 2017.
- [9] Panoramic Power PAN-10. <http://www.panpwr.com/technology>, 2017.
- [10] Pressac CT Clamp. <http://www.pressac.com/current-transducer-enocean-ct-clamp>, 2017.
- [11] Siemens Embedded Micro Metering Module. <http://w3.usa.siemens.com/powerdistribution/us/en/product-portfolio/power-monitoring/energy-management-products/Pages/embedded-submetering-module.aspx>, 2017.
- [12] Texas Instruments CC2538. <http://www.ti.com/product/cc2538>, 2017.
- [13] Watts Up? .Net. <https://www.wattsupmeters.com/secure/products.php?pn=0&wai=0&spec=1>, 2017.
- [14] C. Beckel, W. Kleiminger, R. Cicchetti, T. Staake, and S. Santini. The eco data set and the performance of non-intrusive load monitoring algorithms. In *Proceedings of the 1st ACM Conference on Embedded Systems for Energy-Efficient Buildings*, BuildSys '14, 2014.
- [15] B. Campbell and P. Dutta. Gemini: A non-invasive, energy-harvesting true power meter. In *2014 IEEE Real-Time Systems Symposium*, Dec 2014.
- [16] S. DeBruin, B. Campbell, and P. Dutta. Monjolo: An energy-harvesting energy meter architecture. In *Proceedings of the 11th ACM Conference on Embedded Networked Sensor Systems*, SenSys '13. ACM, 2013.
- [17] S. DeBruin, B. Ghena, Y.-S. Kuo, and P. Dutta. Powerblade: A low-profile, true-power, plug-through energy meter. In *Proceedings of the 13th ACM Conference on Embedded Networked Sensor Systems*, SenSys '15. ACM, 2015.
- [18] S. DeBruin, J. Grunnagle, and P. Dutta. Scaling the wireless ac power meter. In *Proceedings of the 11th International Conference on Information Processing in Sensor Networks*, IPSN '12. ACM, 2012.
- [19] Department of Energy. Low cost wireless electric energy meter specification. <https://www4.eere.energy.gov/alliance/activities/technology-solutions-teams/wireless-meter-challenge>, 2013.
- [20] Department of Energy. BTO FY17-FY19 national laboratory call & merit review. <http://energy.gov/eere/buildings/articles/bto-fy17-fy19-national-laboratory-call-merit-review>, 2016.
- [21] X. Jiang, S. Dawson-Haggerty, P. Dutta, and D. Culler. Design and implementation of a high-fidelity ac metering network. In *Proceedings of the 2009 International Conference on Information Processing in Sensor Networks*, IPSN '09. IEEE Computer Society, 2009.
- [22] M. Lorek, F. Chraim, K. Pister, and S. Lanzisera. Cots-based stick-on electricity meters for building submetering. *Sensors Journal, IEEE*, 14(10), Oct 2014.
- [23] National Science and Technology Council—Committee on Technology. Submetering of building energy and water usage: Analysis and recommendations of the subcommittee on buildings technology research and development, Oct. 2011.
- [24] S. N. Patel, S. Gupta, and M. S. Reynolds. The design and evaluation of an end-user-deployable, whole house, contactless power consumption sensor. In *Proc. of the SIGCHI Conference on Human Factors in Computing Systems*, CHI '10. ACM, 2010.
- [25] N. Rajagopal, S. Giri, M. Berges, and A. Rowe. A magnetic field-based appliance metering system. In *2013 ACM/IEEE International Conference on Cyber-Physical Systems (ICCP)*, April 2013.
- [26] T. Schmid, D. Culler, and P. Dutta. Meter any wire, anywhere by virtualizing the voltage channel. In *Proceedings of the 2Nd ACM Workshop on Embedded Sensing Systems for Energy-Efficiency in Building*, BuildSys '10. ACM, 2010.
- [27] R. Send, Q. Xu, I. Paprotny, R. White, and P. Wright. Granular radio energy-sensing node (green): A 0.56 cm³ wireless stick-on node for non-intrusive energy monitoring. In *SENSORS, 2013 IEEE*, Nov 2013.
- [28] U.S. Energy Information Administration. Annual energy outlook, 2015.
- [29] Q. Xu, I. Paprotny, M. Seidel, R. White, and P. Wright. Stick-on piezoelectromagnetic AC current monitoring of circuit breaker panels. *Sensors*, 13(3), March 2013.